

Modulate Ladder Accent 02

MOD-ML-02-B
 MOD-ML-02-DW
 MOD-ML-02-S
 MOD-ML-02-WD

Modulate accent enhances the functionality of your modualte frame (9,10,13 & 14) or backwall kit and adds more real estate for messaging and merchandise displaying too!. Add this easy to assemble accent to turn your frame into a kiosk that features a monitor mount and counter space.



Top View

features and benefits:

- Medium monitor mount; 32"-55" max monitor size.
- Max monitor weight of 20lbs
- Max counter support of 25lbs
- Kit includes: Top fabric structure, medium monitor mount, modulate counter, and graphics for both the top tube structure and the counter
- 1 year hardware warranty against manufacturer defects

dimensions:

Hardware

Assembled unit:
 31.5"w x 96.2"h x 23.5"d
 801mm(w) x 2444mm(h) x 597mm(d)

Approximate weight with cases:
 28 lbs / 13 kgs

Graphic

Refer to related graphic template for more information.

One year warranty

Visit:
<https://www.theexhibitorshandbook.com/download-graphic-templates>

Shipping

Packing case(s):
 1 Box

Shipping dimensions:
 37"l x 27"h x 8"d
 940mm(l) x 686mm(h) x 204mm(d)

Approximate total shipping weight (includes cases & graphics):
 33 lbs / 15 kgs

additional information:

Graphic material:
 Top tube sturcture: Dye-sublimation zipper pillowcase fabric
 Counter graphic: Dye-sublimation graphic

To be used with frames 9,10,13 & 14

When included in a larger kit, a different packaging solution will be listed to accommodate all contents of the kit. Individual packaging no longer provided.

Tabletop Colors:

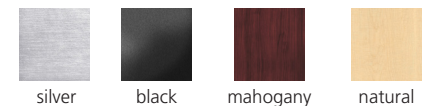

This product may include the following materials for recycle:
 aluminum, select wood, fabric, cardboard, paper, steel, and plastics.

We are continually improving and modifying our product range and reserve the right to vary the specifications without prior notice. All dimensions and weights quoted are approximate and we accept no responsibility for variance. E&OE. See Graphic Templates for graphic bleed specifications.

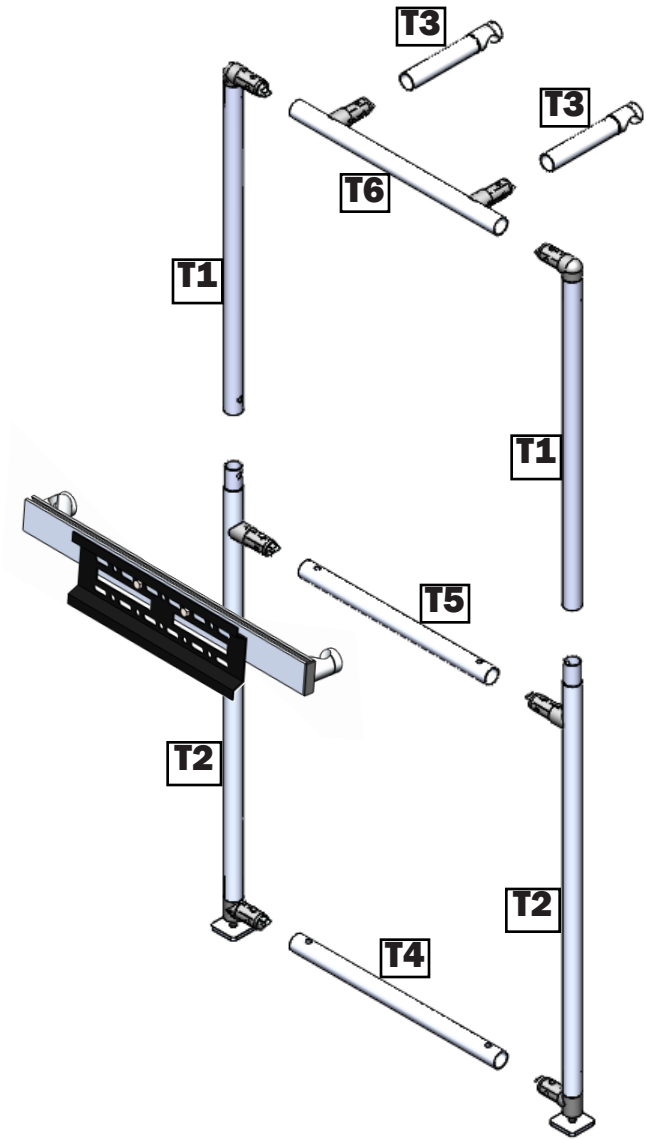
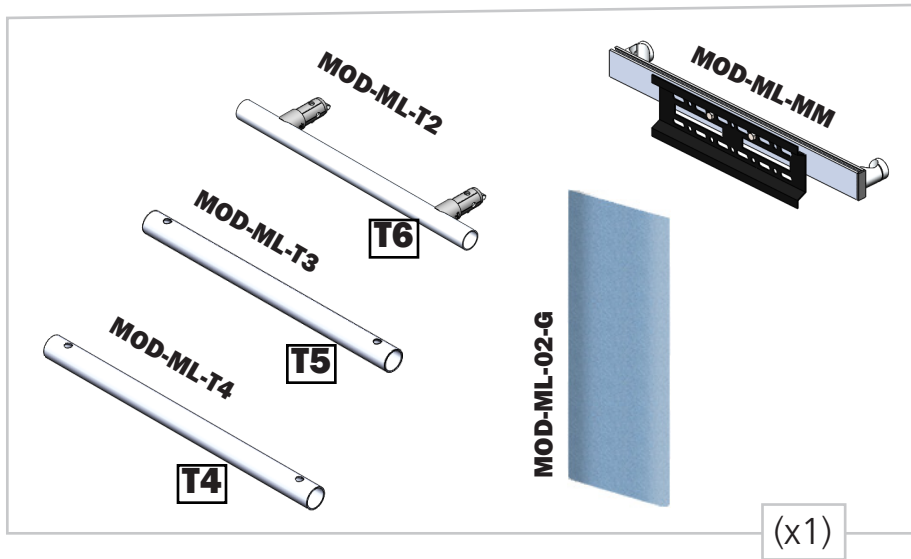
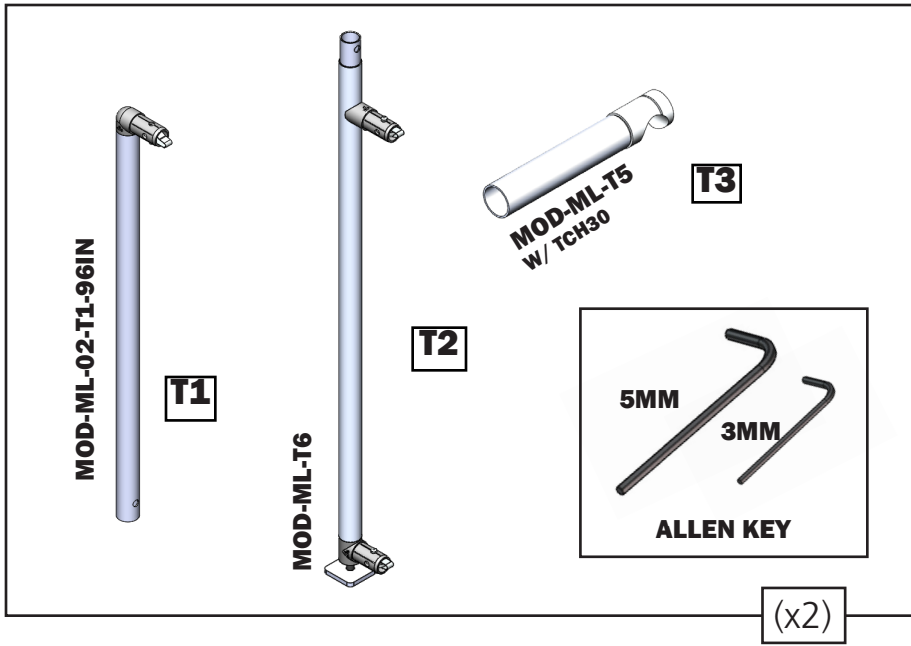

For this step you will need:

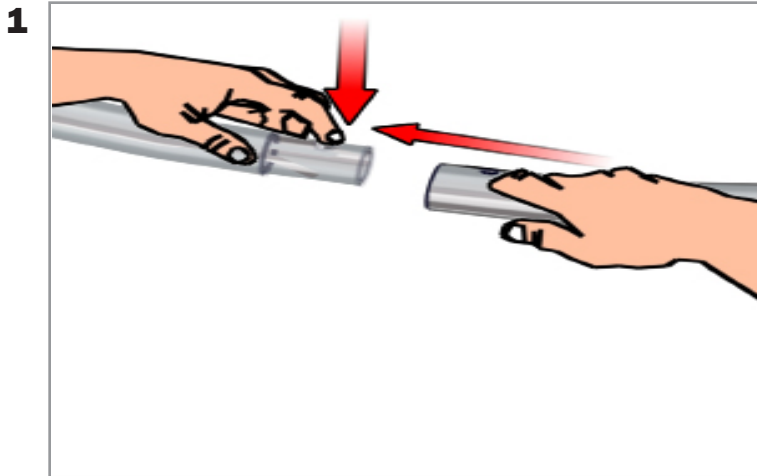

Assemble rectangular frame by connecting tubes with push button fit as labeled to the right.

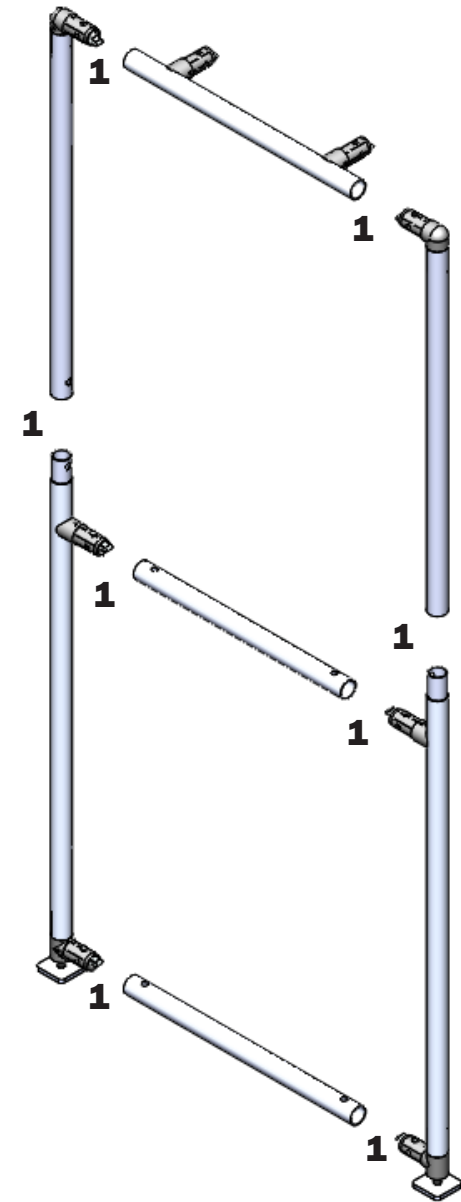

For this step you will need:

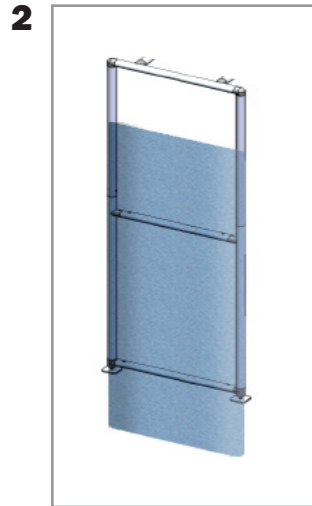

Install the graphic by inserting the bottom of the frame into the pillowcase graphic and pulling up. Make sure to have the graphic cut outs around the protruding posts at the top of the ladder.

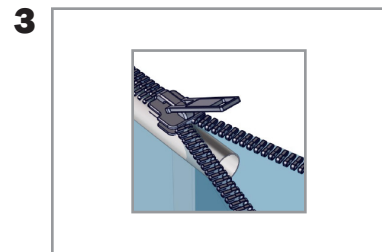

Zip the graphic closed at the top of the frame.

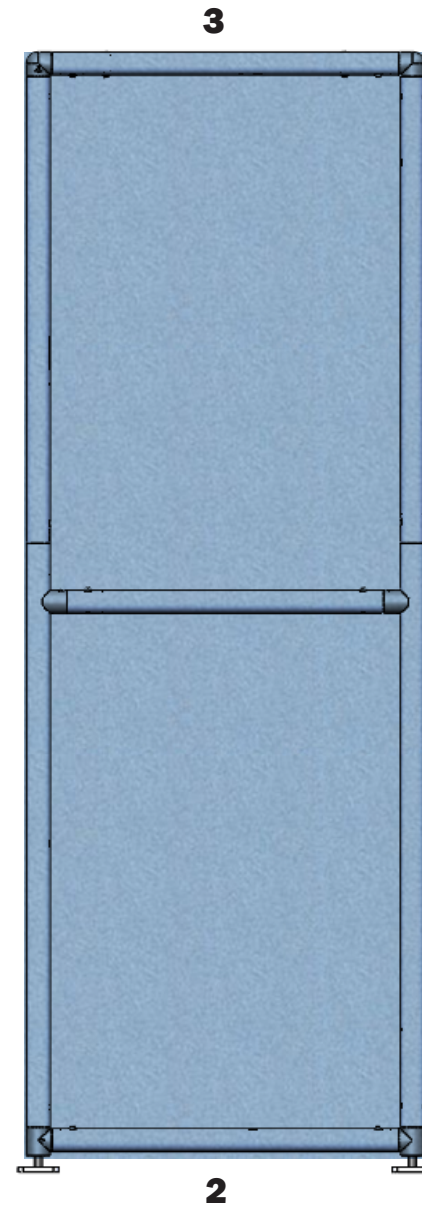

For this step you will need:

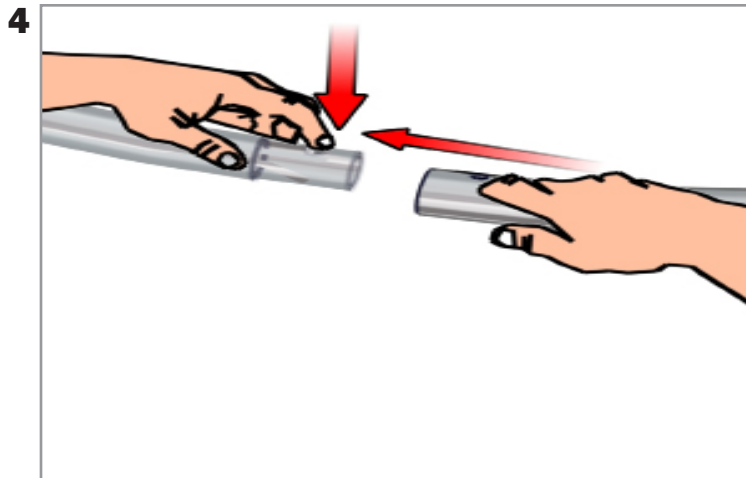
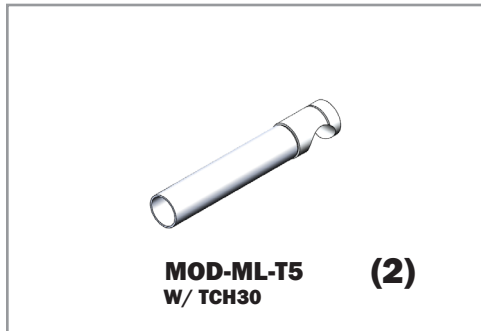

Connect the remaining tubes with push button fit as labeled below using the same method from Step 1.

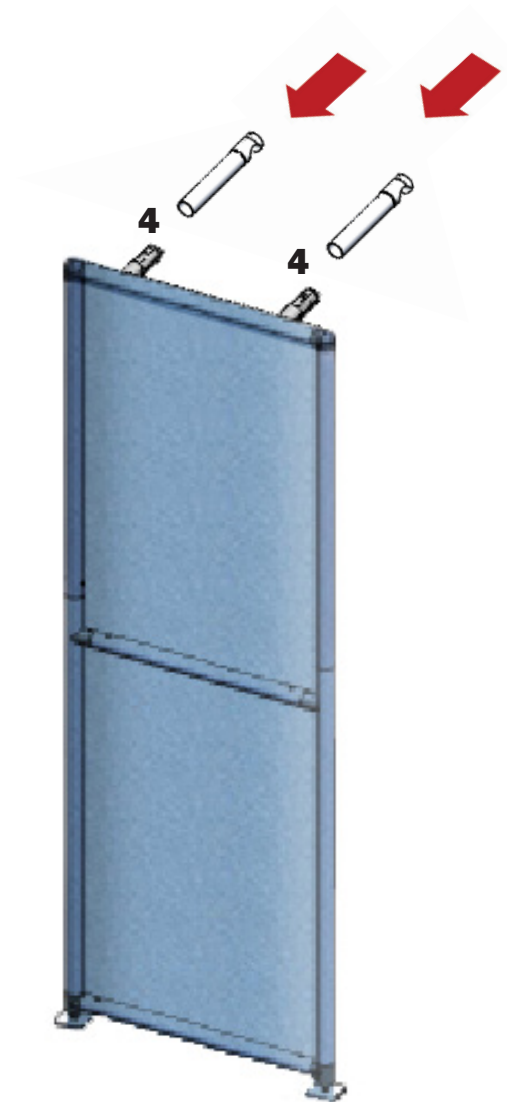

For this step you will need:

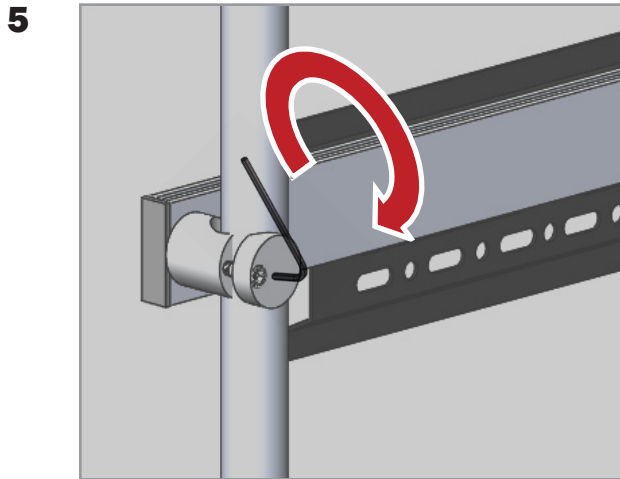
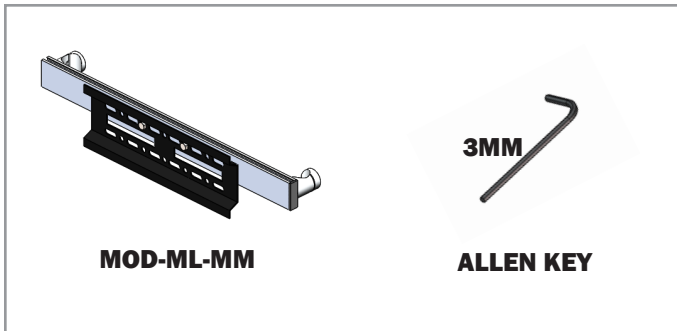

Using the allen key attach the monitor mount to the ladder. Standard height is 80 inches from the base of the counter.

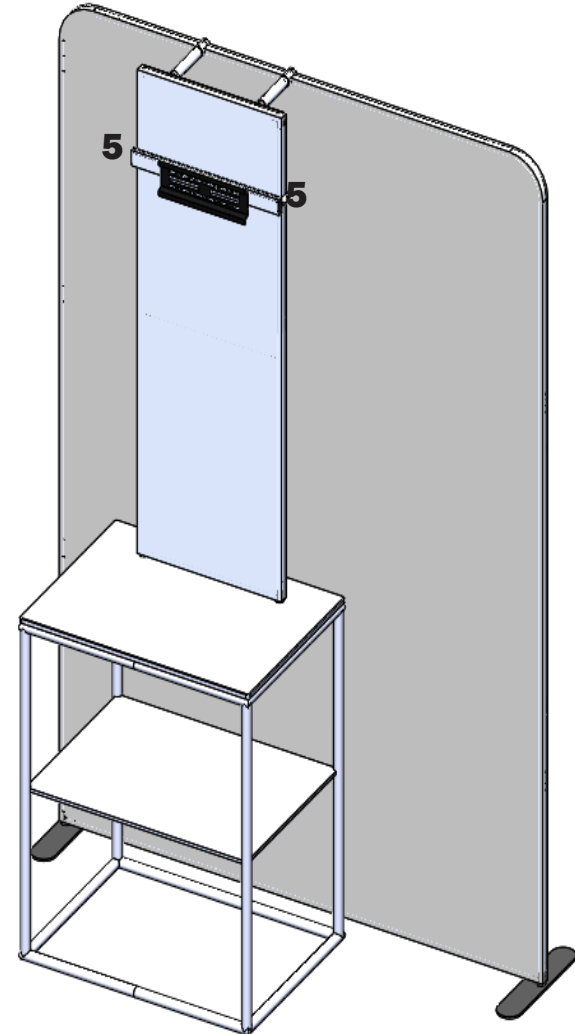

For this step you will need:

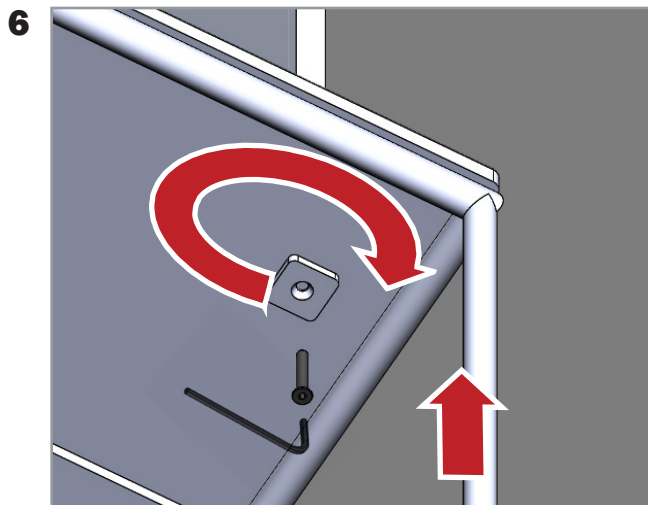
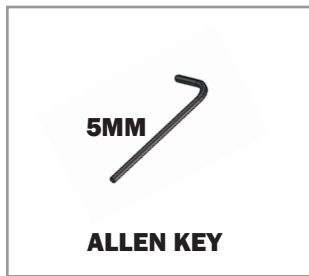

Using the allen key attach the ladder to the counter using the provided screw.

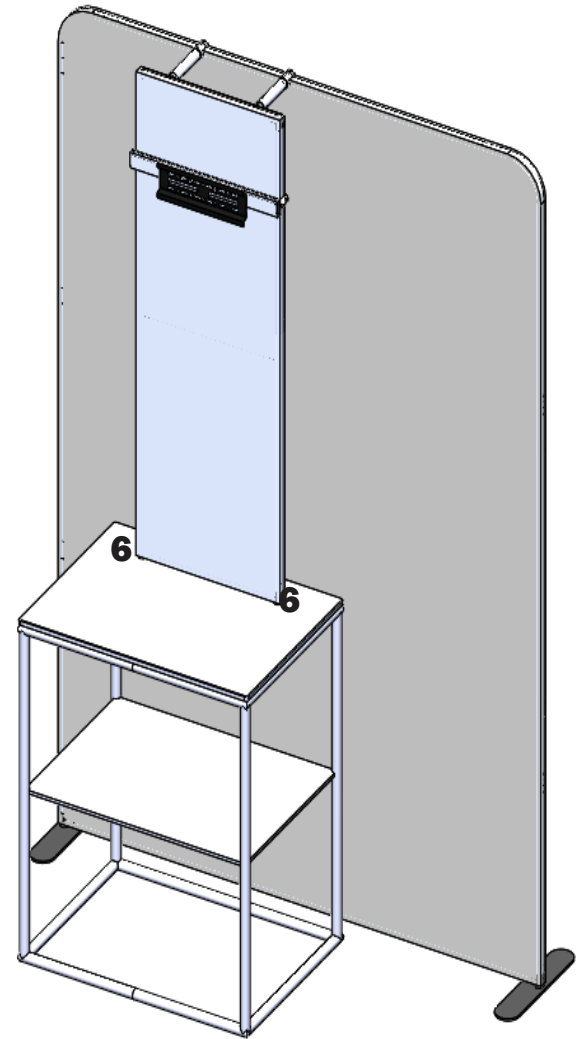

For this step you will need:

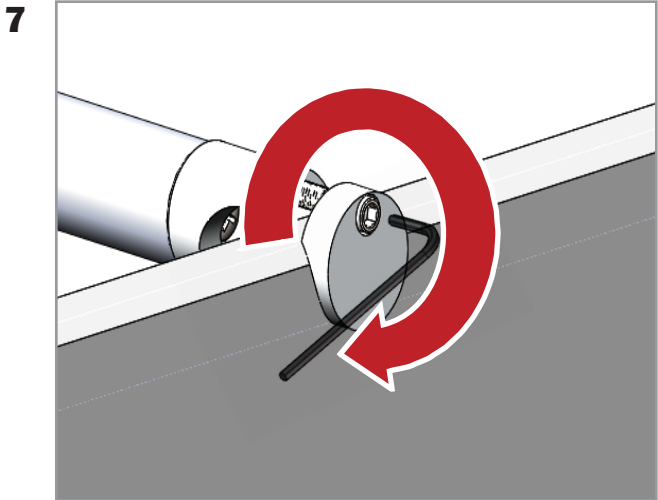
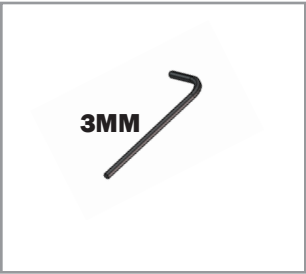

Using the allen key attach the ladder to the backing frame.

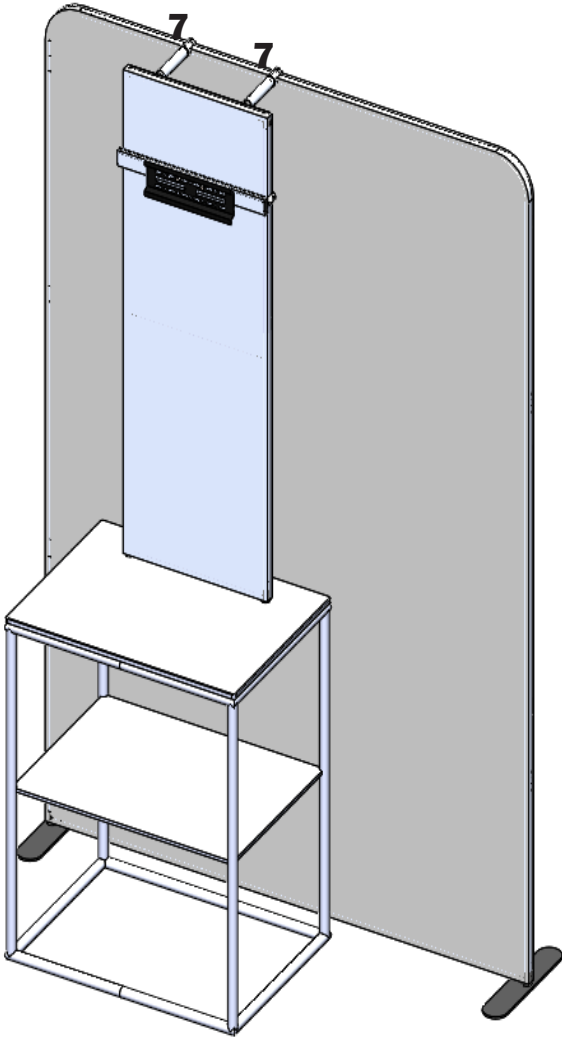

*** Backwall frame not included**

Modulate Magnetic Counter

MOD-CNTR-M-B
 MOD-CNTR-M-DW
 MOD-CNTR-M-W
 MOD-CNTR-M-S

The Modulate™ Magnetic Counter accents the Modulate line of mix and match banners and reconfigurable exhibit kits. Couple Modulate banners with the Modulate Counter to create kiosks and workstations for use in tradeshow exhibits, at events and in more permanent settings. The Modulate Magnetic Counter comes with a magnetic, snap-button tube frame, an internal shelf, a printed stretch fabric graphic and a portable carry bag. The graphic spans the perimeter of the frame and attaches with hook and loop, making it easy to get inside the counter for what you need.

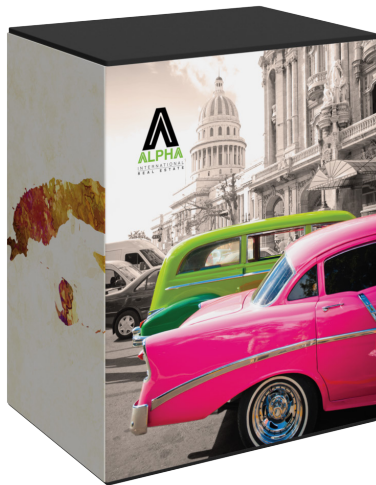

features and benefits:

- Portable display counter
- Magnetized, aluminum tube frame
- Top available in four thermoform finish options
- Quick to set-up
- Stretch fabric graphics attach with hook and loop velcro
- Includes internal shelf
- Carry bag included
- Easy to store and ship
- One year hardware warranty against manufacturer defects

dimensions:

Hardware

Graphic

Assembled unit:
 31.5" w x 40" h x 23.5" d
 801mm(w) x 1016mm(h) x 597mm(d)

Refer to related graphic template for more information.

Approximate weight:
 22 lbs / 10 kg

One year warranty.

Visit:
www.exhibitors-handbook.com/graphic-templates

Shipping

additional information:

Packing case(s):
 1 Box(es)

Shipping dimensions:
 37" l x 27" h x 8" d
 940mm(l) x 686mm(h) x 204mm(d)

When included in a larger kit, a different packaging solution will be listed to accommodate all contents of the kit. Individual packaging no longer provided.

Approximate total shipping weight:
 25 lbs / 12 kg

	CAUTION Interaction with metallic objects may cause Pinch Hazards.
	Persons with medical implants be advised magnets may interfere with your device.
Strong Magnetic Field	

Recommended Case:
 1 OCFM (2 Units Per case)

Tabletop Colors:

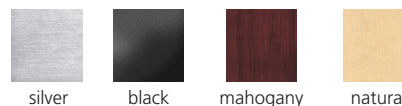

Use caution when handling this product around mechanical wrist watches, metal tools, electronic devices, credit cards or any other similar items. DO NOT place any part of the body, such as fingers, hands, etc, between the magnetic surface areas of the components.

We are continually improving and modifying our product range and reserve the right to vary the specifications without prior notice. All dimensions and weights quoted are approximate and we accept no responsibility for variance. E&OE. See Graphic Templates for graphic bleed specifications.

Included In Your Kit

Tools, Components, & Connectors



MOD-CNTR-M-TOP-(COLOR) x1



MOD-CNTR-M-IS x1

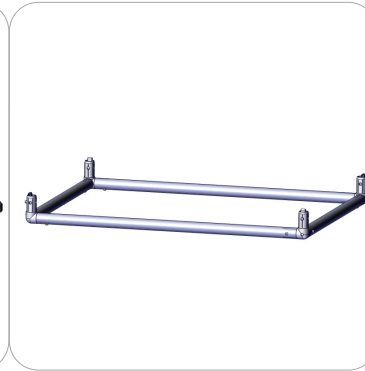

MOD-CNTR-M-T1 x1

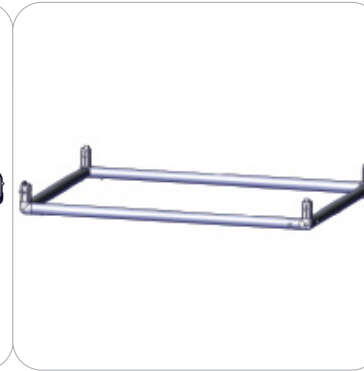

MOD-CNTR-M-T2 x1

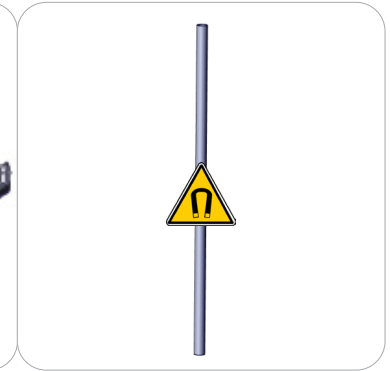

MOD-CNTR-M-T3 x4

	<p>CAUTION</p> <p>Interaction with metallic objects may cause Pinch Hazards.</p> <p>Persons with medical implants be advised magnets may interfere with your device.</p>
<p>Strong Magnetic Field</p>	

Graphics

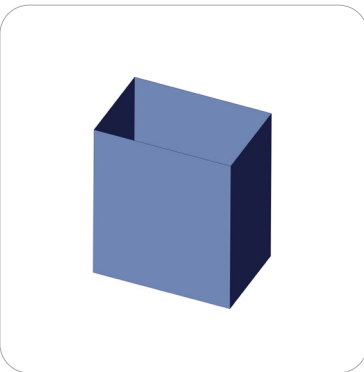

MOD-CNTR-M-G x1

Dimensions

MOD-CNTR-M-B

31.5in
[801mm]

23.5in
[597mm]

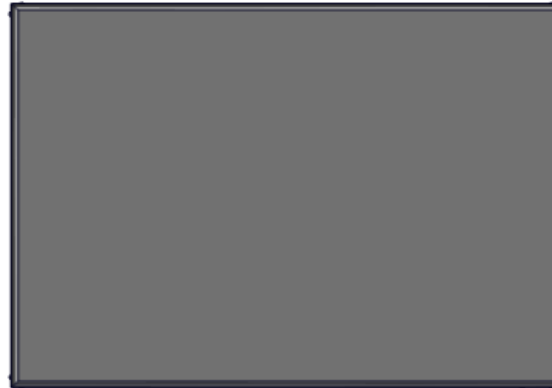

40in
[1016mm]

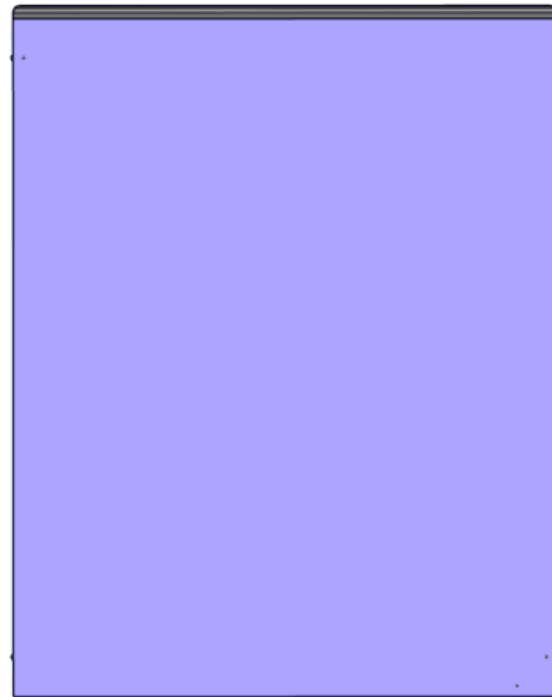

	CAUTION
	Interaction with metallic objects may cause Pinch Hazards. Persons with medical implants be advised magnets may interfere with your device.
Strong Magnetic Field	

Labeling Diagram

MOD-CNTR-M-B

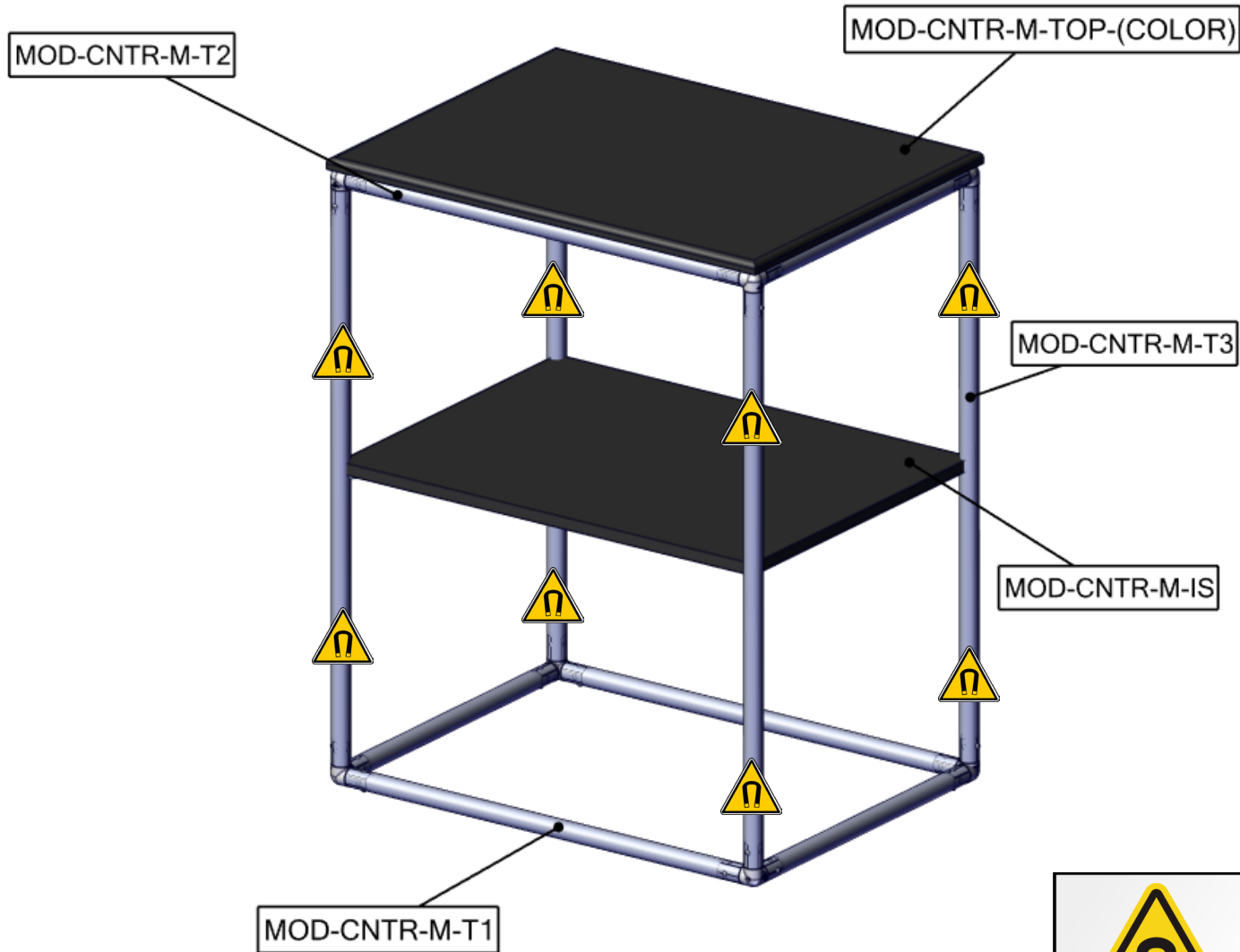

	CAUTION
	Interaction with metallic objects may cause Pinch Hazards. Persons with medical implants be advised magnets may interfere with your device.
Strong Magnetic Field	

Kit Assembly

Step by Step

Step 1.

Gather the components to build the frame. Use the Exploded View for part labels.

Reference Connection Method(s) 1 for more details.

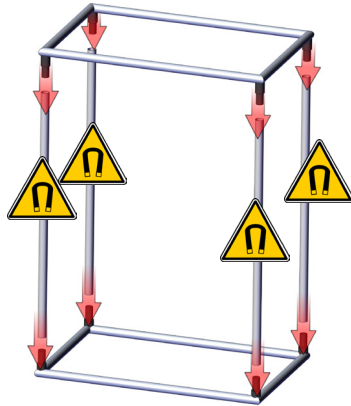

Step 2.

Rest the internal shelf on the pre-installed pin located on all 4 vertical 30mm tubes.

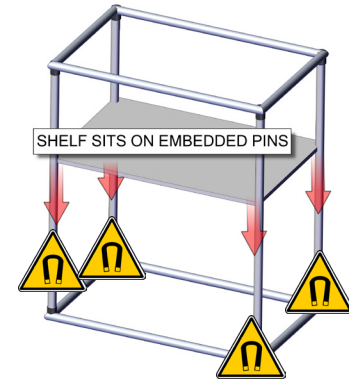
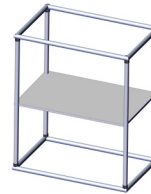

Step 3.

Place the countertop on the frame. Use the Exploded View for part labels.

Reference Connection Method 2 for more details.

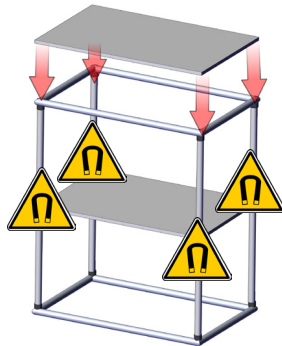

CT-BLOCKS ARE FOUND UNDER THE COUNTER.

Step 4.

the Graphic is attached to the counter with hook & loop fasteners. The hook fastener is on the top and bottom outside tubes. Start in one corner and wrap the graphic around the frame. Once you have returned to the starting point, adjust as needed then zipper the graphic closed.

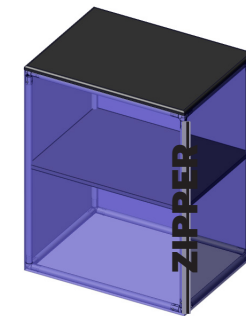
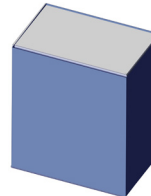

BACK VIEW

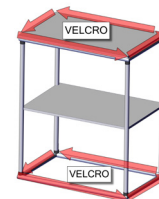

Connection Methods

Connection Method 1: PUSH TAB CONNECTION

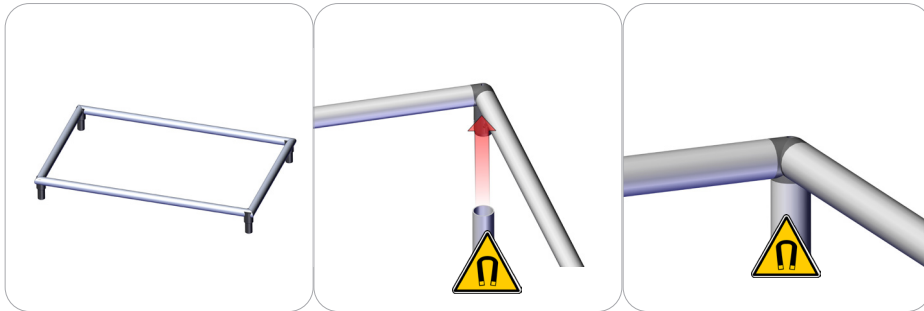

The top and bottom come pre-assembled. the top tubes are riveted to the connector. The SIDE SUPPORT tubes will snap into place shown in the picture above using a push tab lock. The SIDE SUPPORTS lock the top and bottom frames together.

Connection Method 2: CT-BLOCKS/ COUNTER TOP

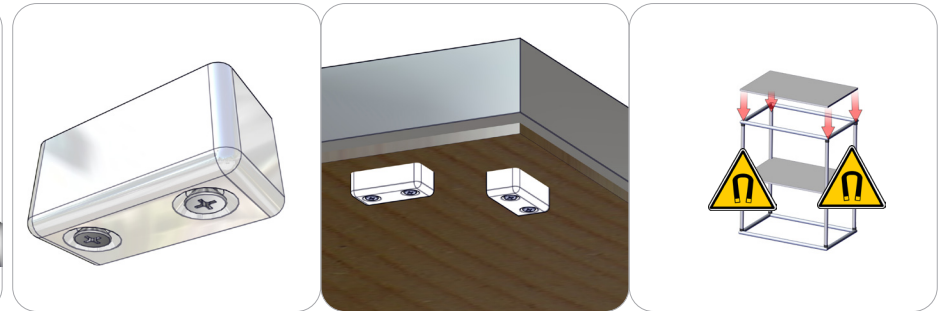

Plastic CT-BLOCK will come attached to the bottom of the Counter top. This helps the Counter to not slide around on the tubes. Any cutting of the tubes or screws would weaken the strength of the tubes. So, CT-BLOCKS are used.

Counter Top - Electronic Device Instructions

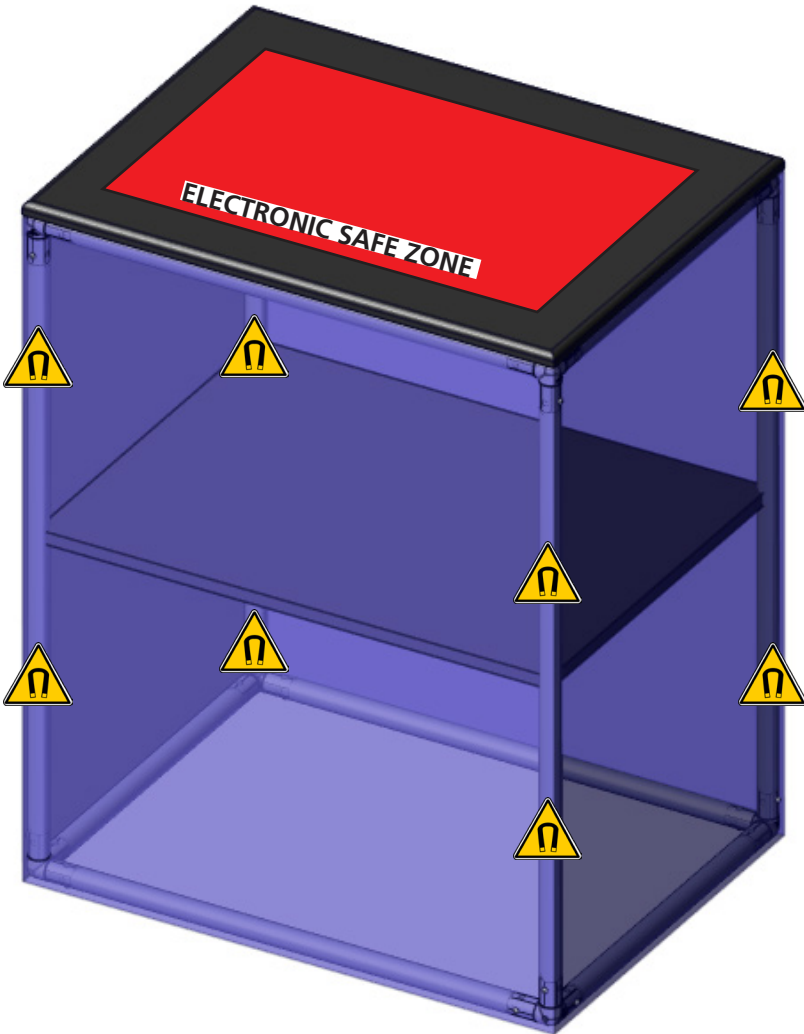

Warning:
Keep electronic devices within the safe zone. 2" from the outer frame is the recommended distance. The magnet could cause interruptions with electronics.



TOP VIEW