

1 STEP 1

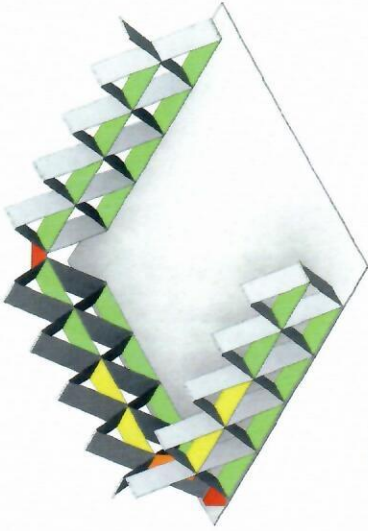

2 STEP 2

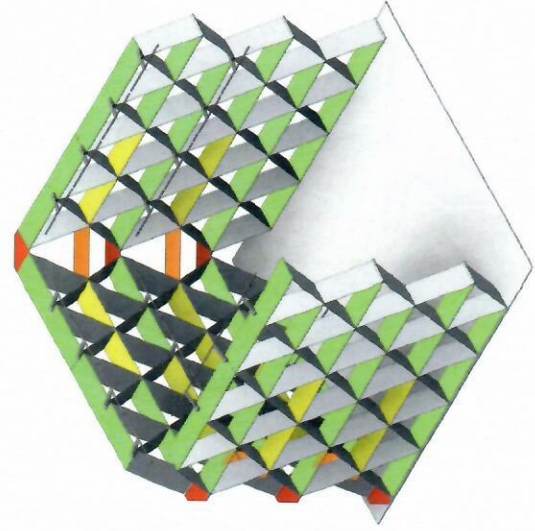

3 STEP 3

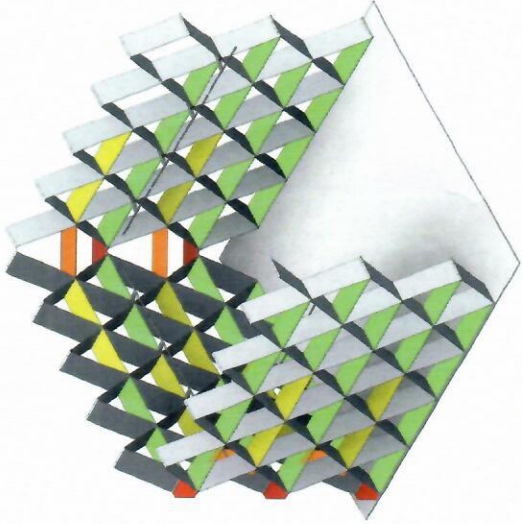

4 STEP 4

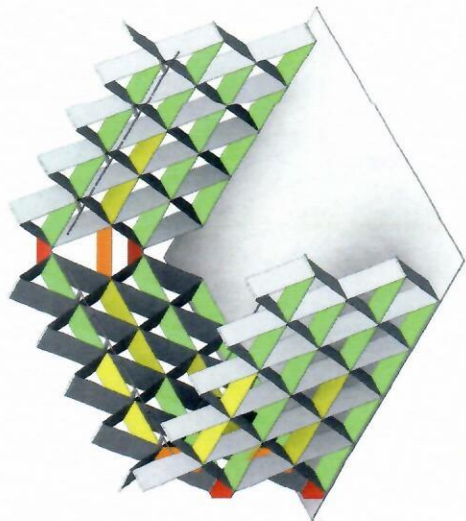

5 STEP 5

6 STEP 6

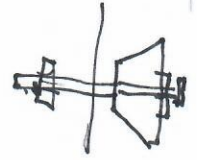
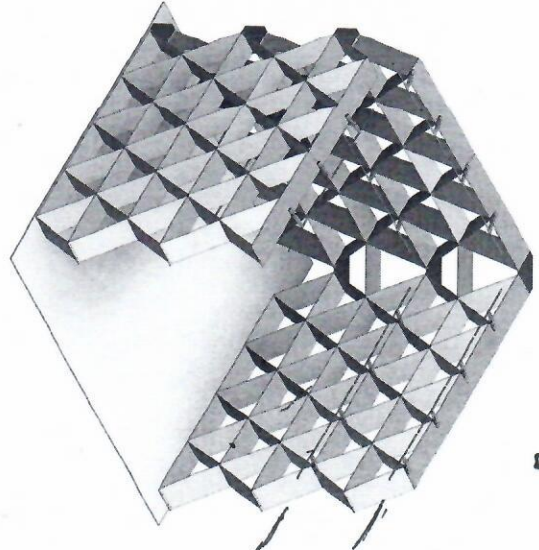
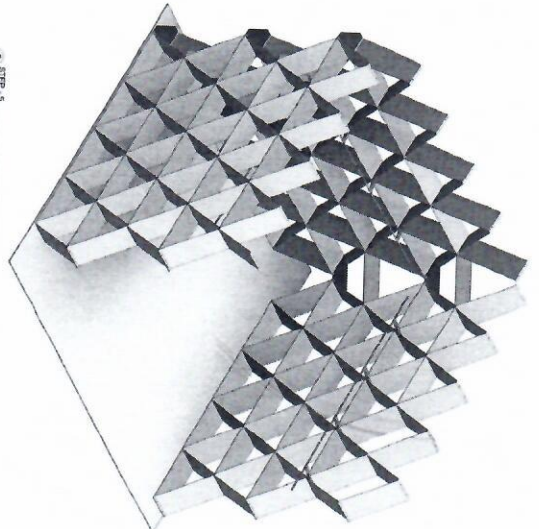
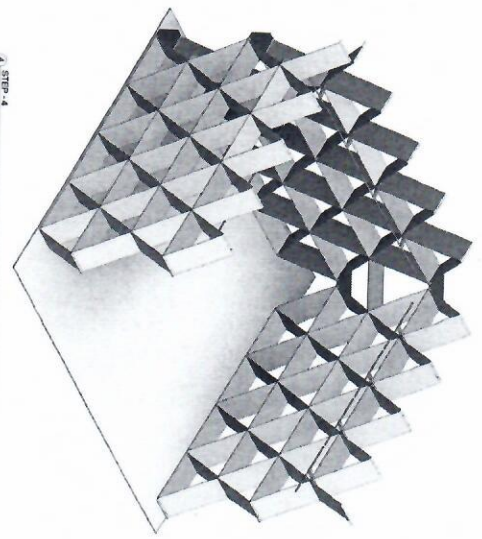
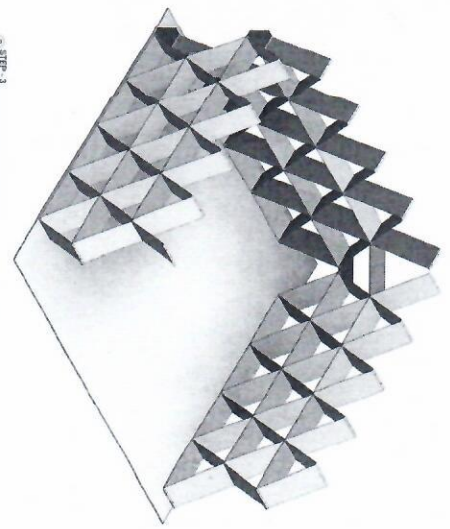
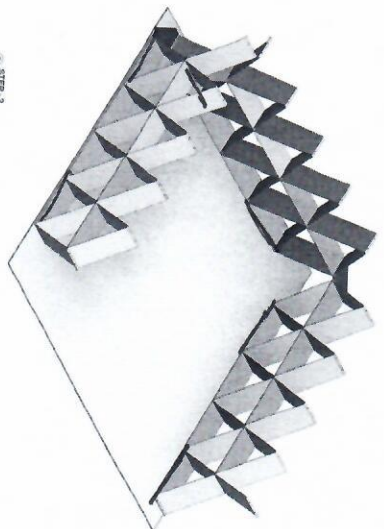
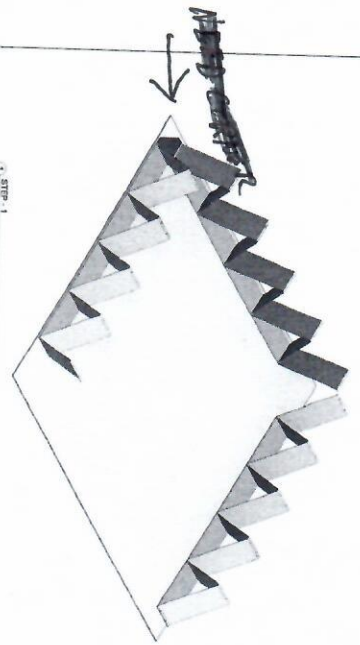

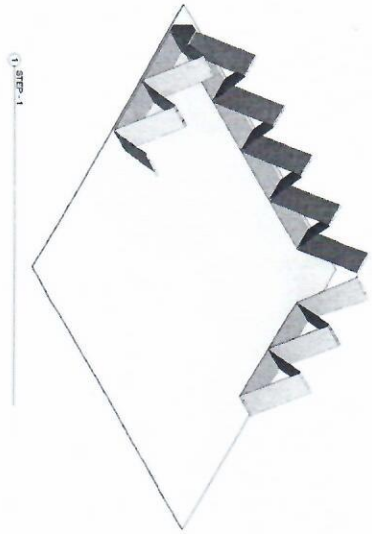

1. STEP-1

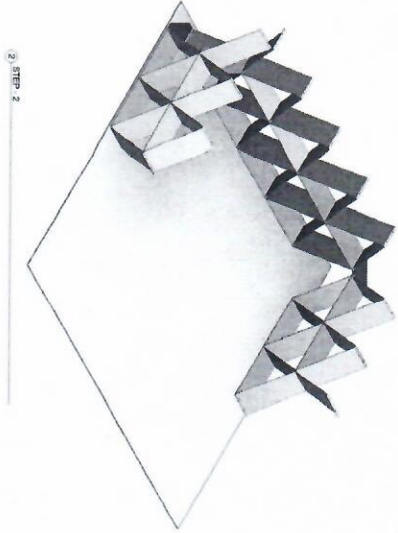

2. STEP-2

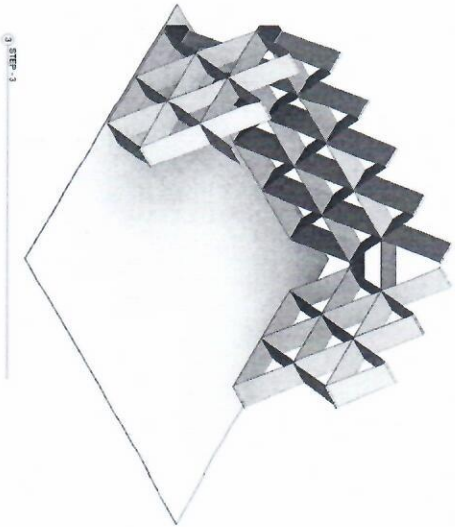

3. STEP-3

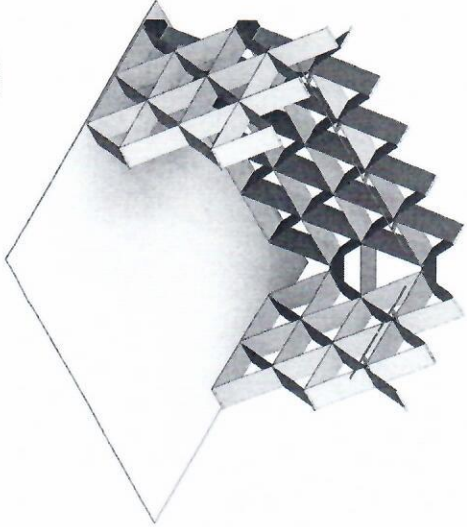

4. STEP-4

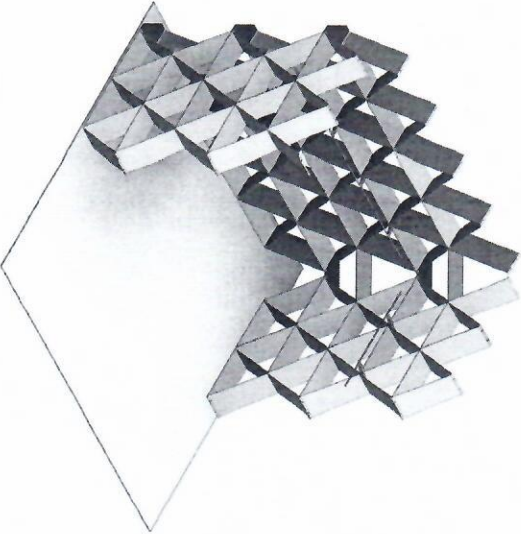

5. STEP-5

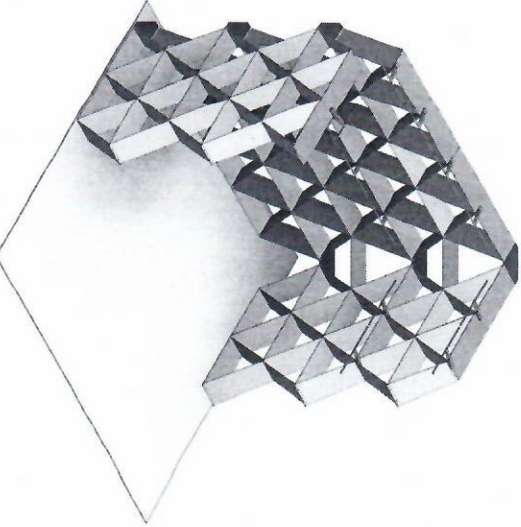

6. STEP-6



16 TYPICAL SHELVES



8 SHELVES ADJACENT TO LONG CORNERS

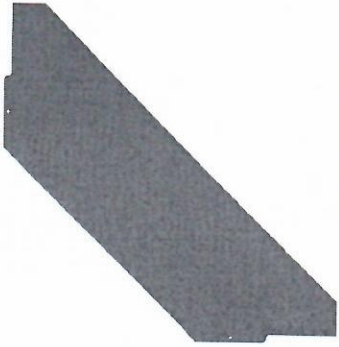

4 LONG CORNERS



6 SHORT CORNERS

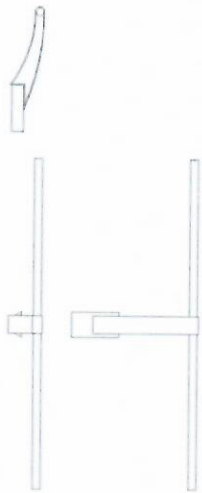

14 LED LIGHT FIXTURES



35 ALUMINUM Z

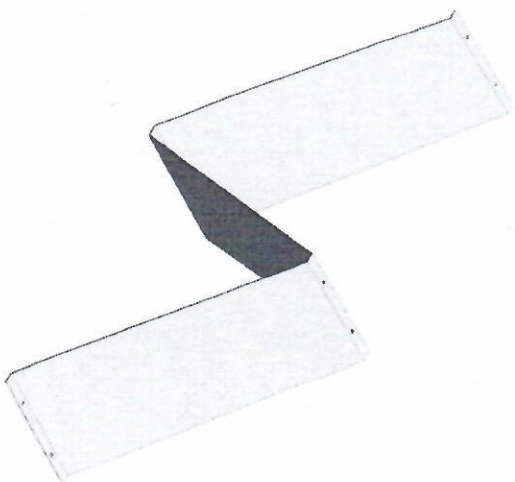



3 Z SHAPE



4 Z SHAPE
3'-0" x 1'-0"

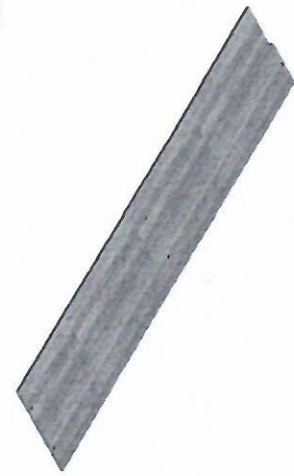

6 SHELF

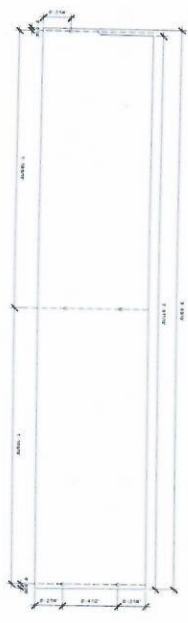

7 SHELF
3'-0" x 1'-0"



1 CORNER



2 CORNER
3'-0" x 1'-0"

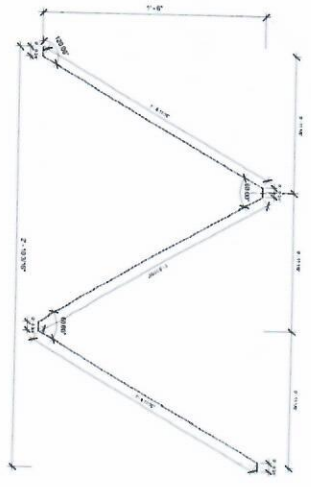

8 Z SHAPE
3'-0" x 1'-0"



28 TYPICAL SHELVES



8 SHELVES ADJACENT TO LONG CORNERS

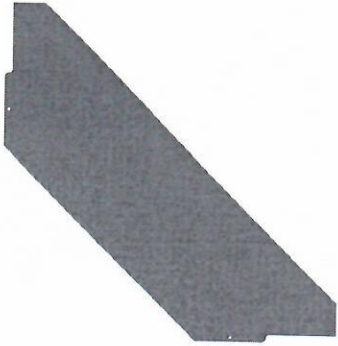

4 LONG CORNERS



6 SHORT CORNERS

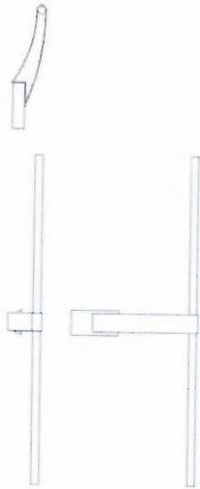

22 LED LIGHT FIXTURES

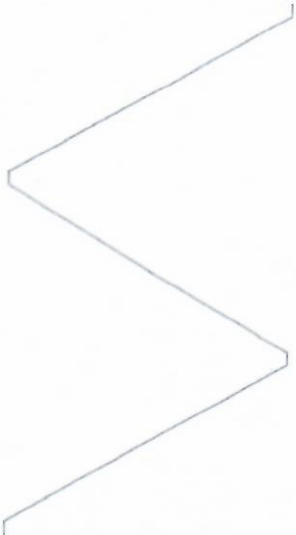
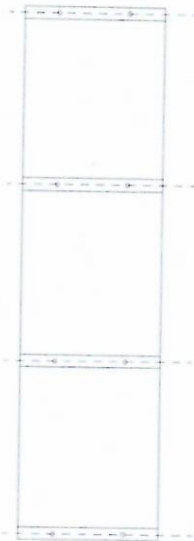

45 ALUMINUM Z

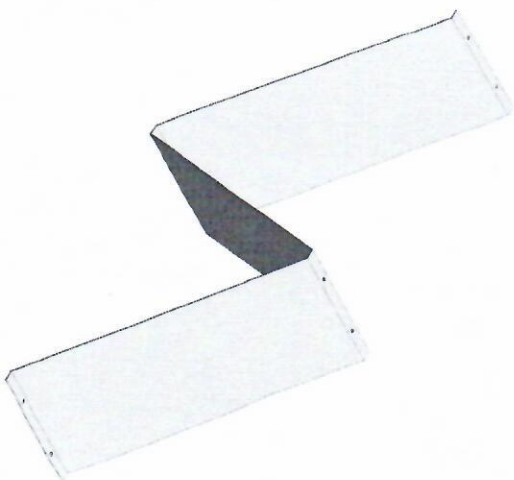

4 LEFT
3/4" = 1'-0"

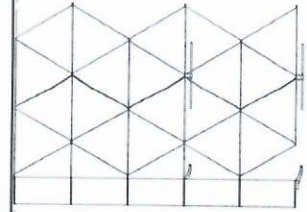

Level 1

3 BACK
3/4" = 1'-0"

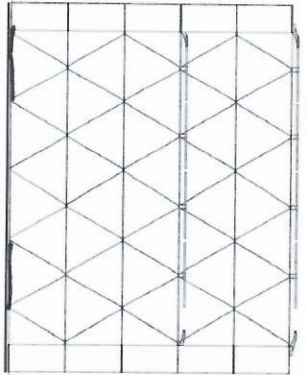

Level 1

2 RIGHT
3/4" = 1'-0"

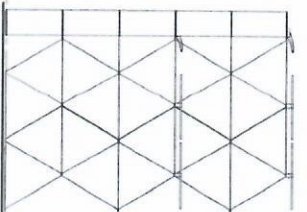

Level 1

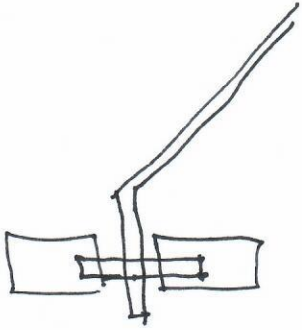

1 Level 1
3/4" = 1'-0"

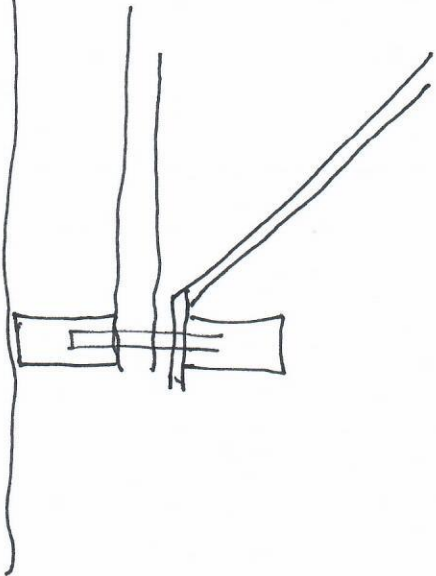
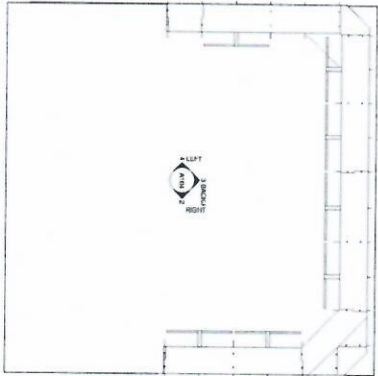



16 TYPICAL SHELVES



8 SHELVES ADJACENT TO LONG CORNERS

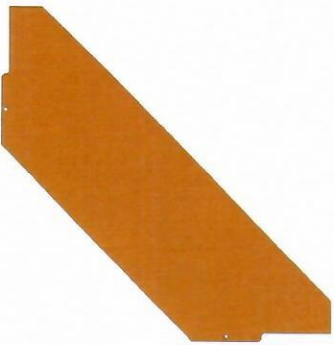

4 LONG CORNERS



6 SHORT CORNERS



14 LED LIGHT FIXTURES

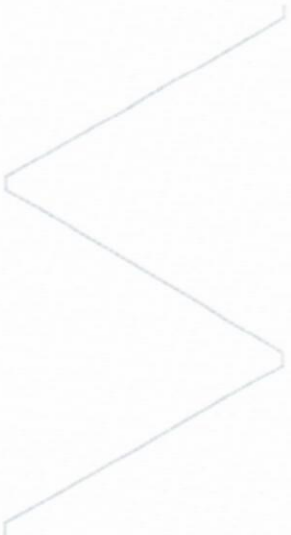

35 ALUMINUM Z

